

Article number: 20191B15B152NI

Description: E+G

T-angle clamps GN191-B15-B15-22-NI

Measures

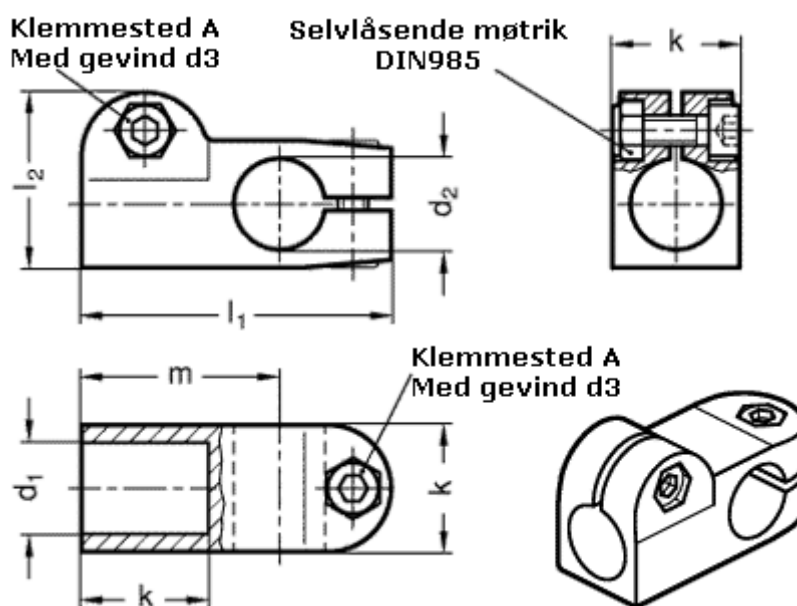

d1 = B15
d2 = B15
d3 = M 6
k = 25
l1 = 61
l2 = 34.5
m = 39